

elevation

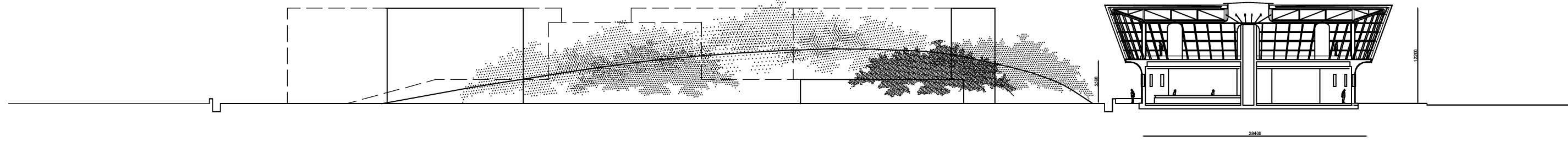

section

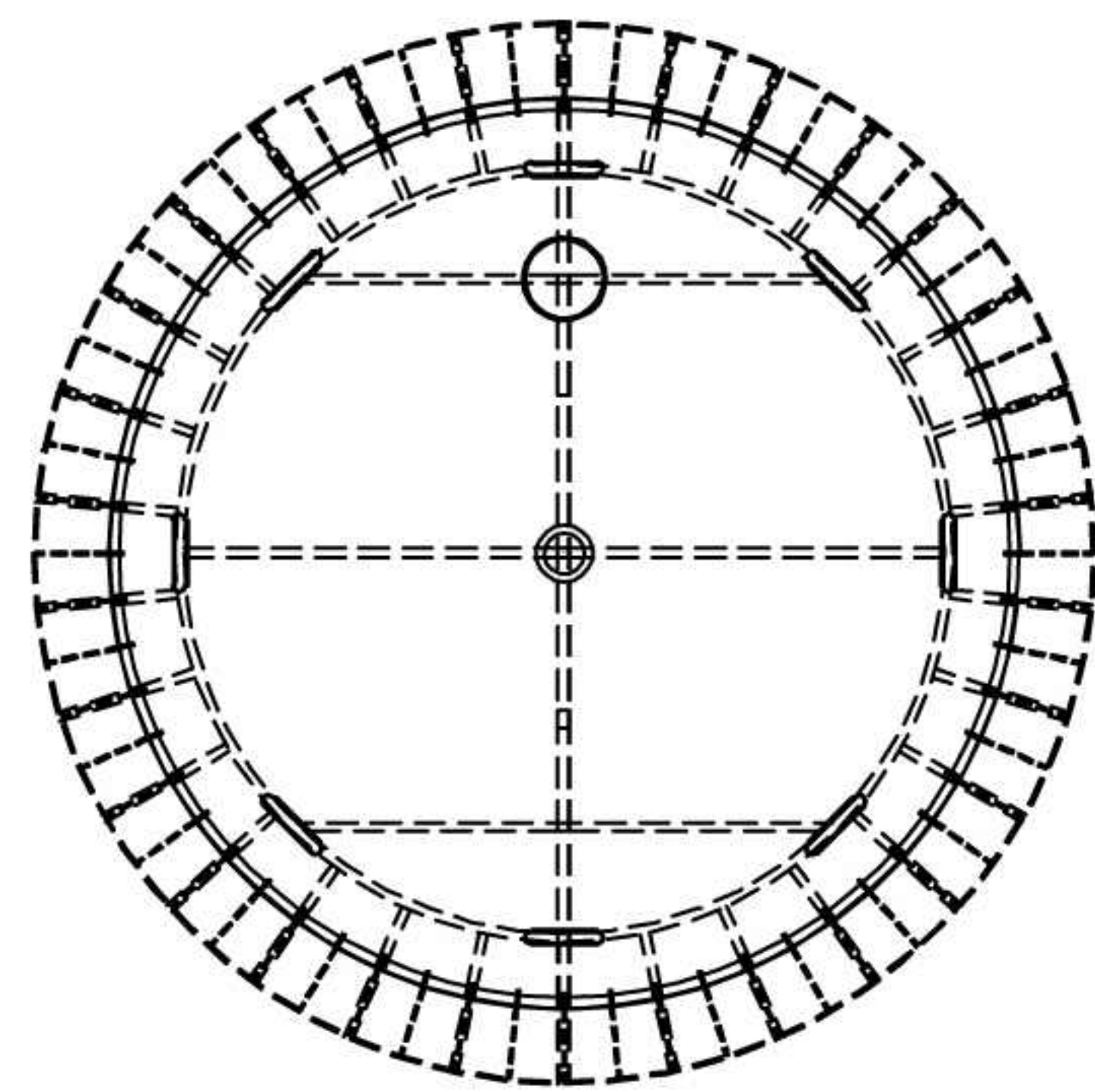

roof

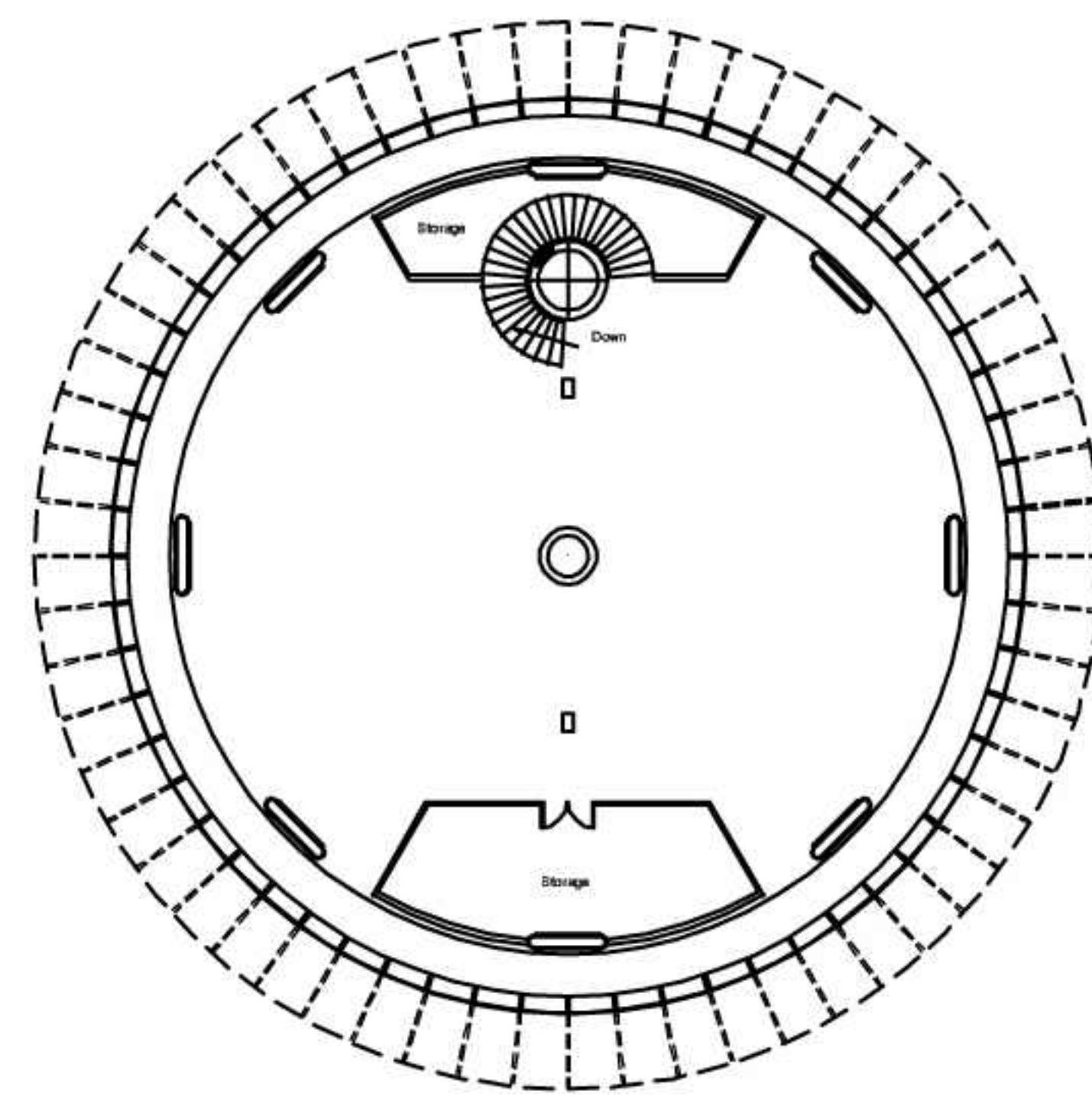

Level 2

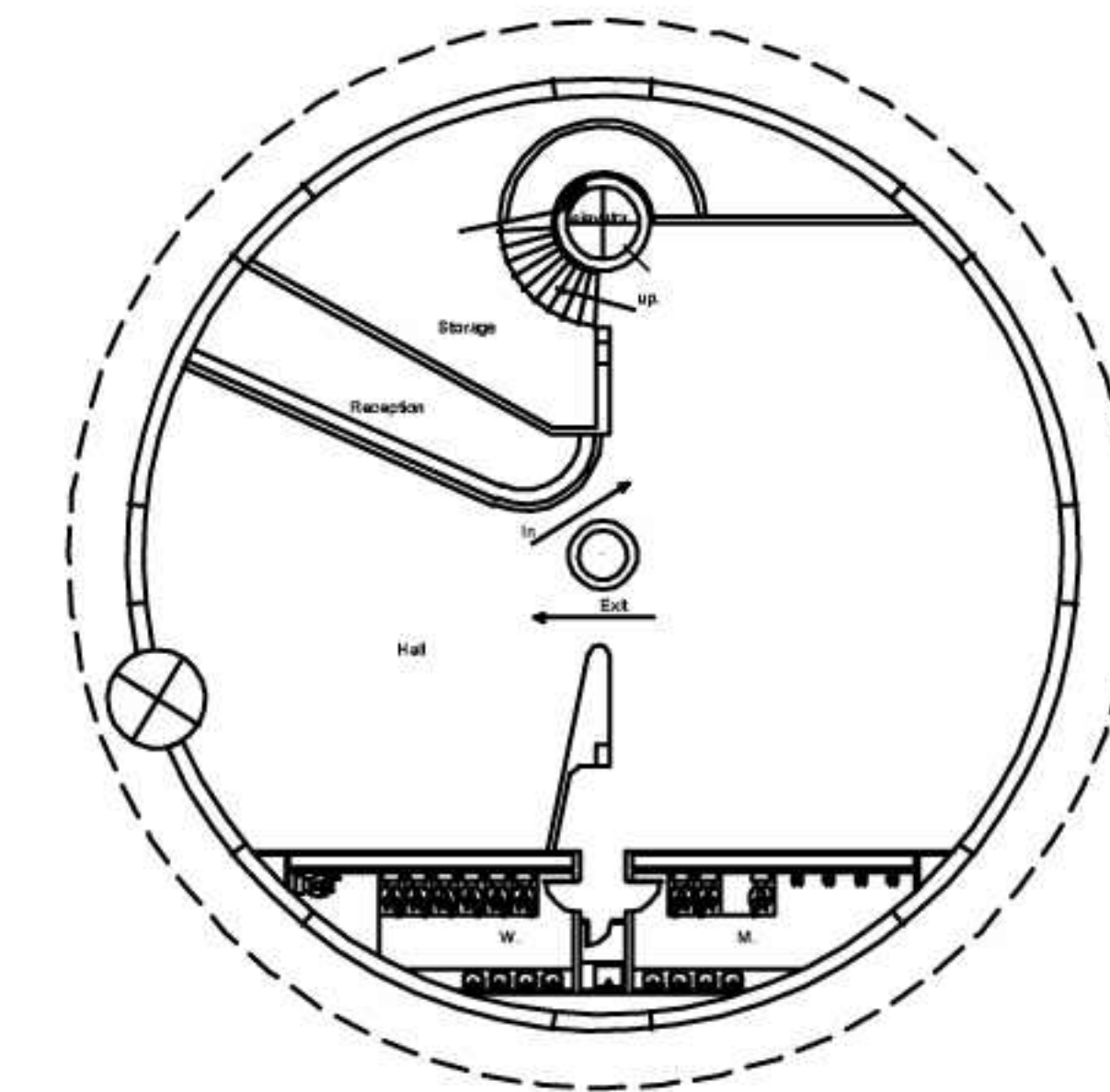

Level 1



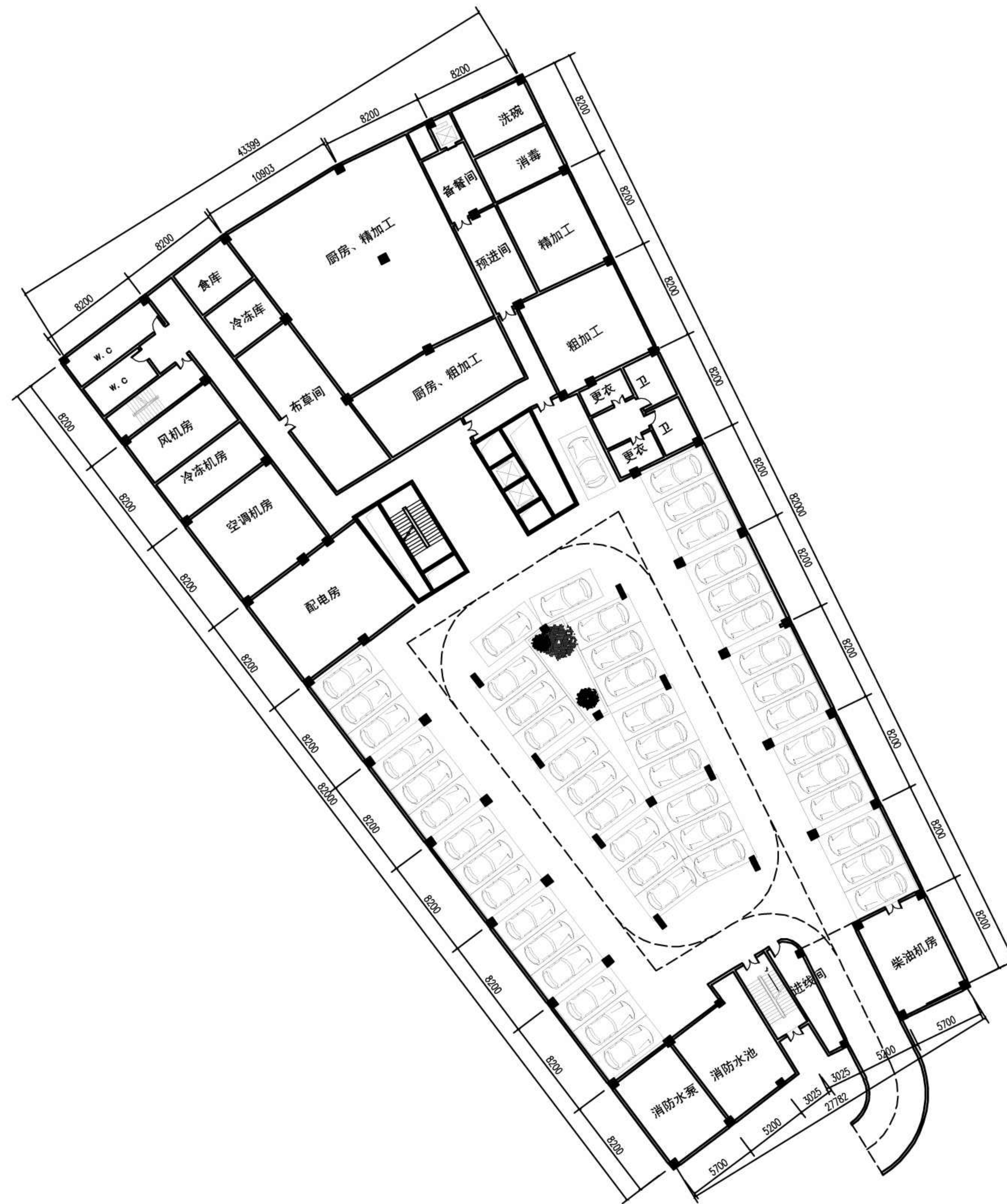

level -1f 负一层平面图 1:300 (地下车库车位: 48)



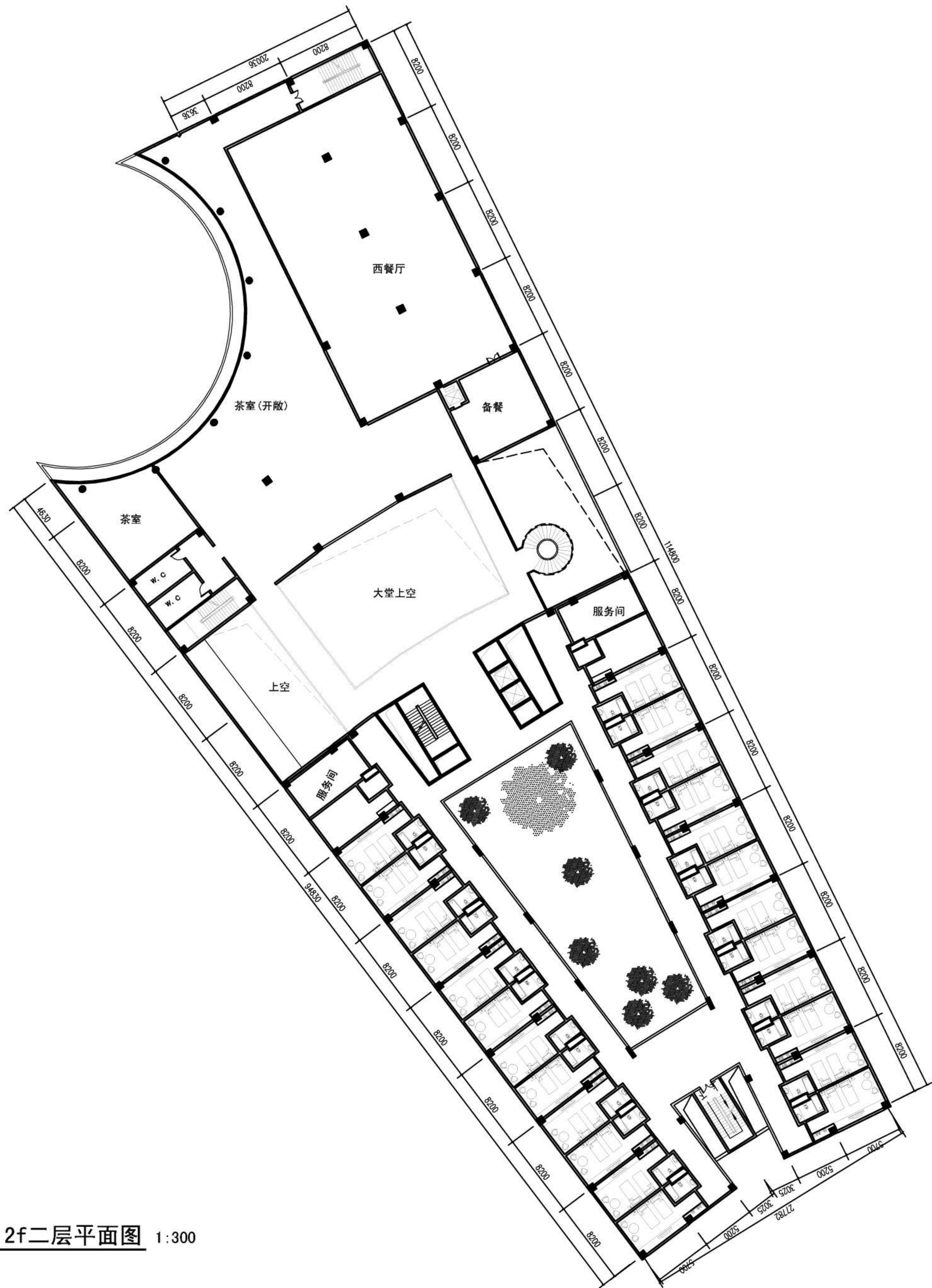
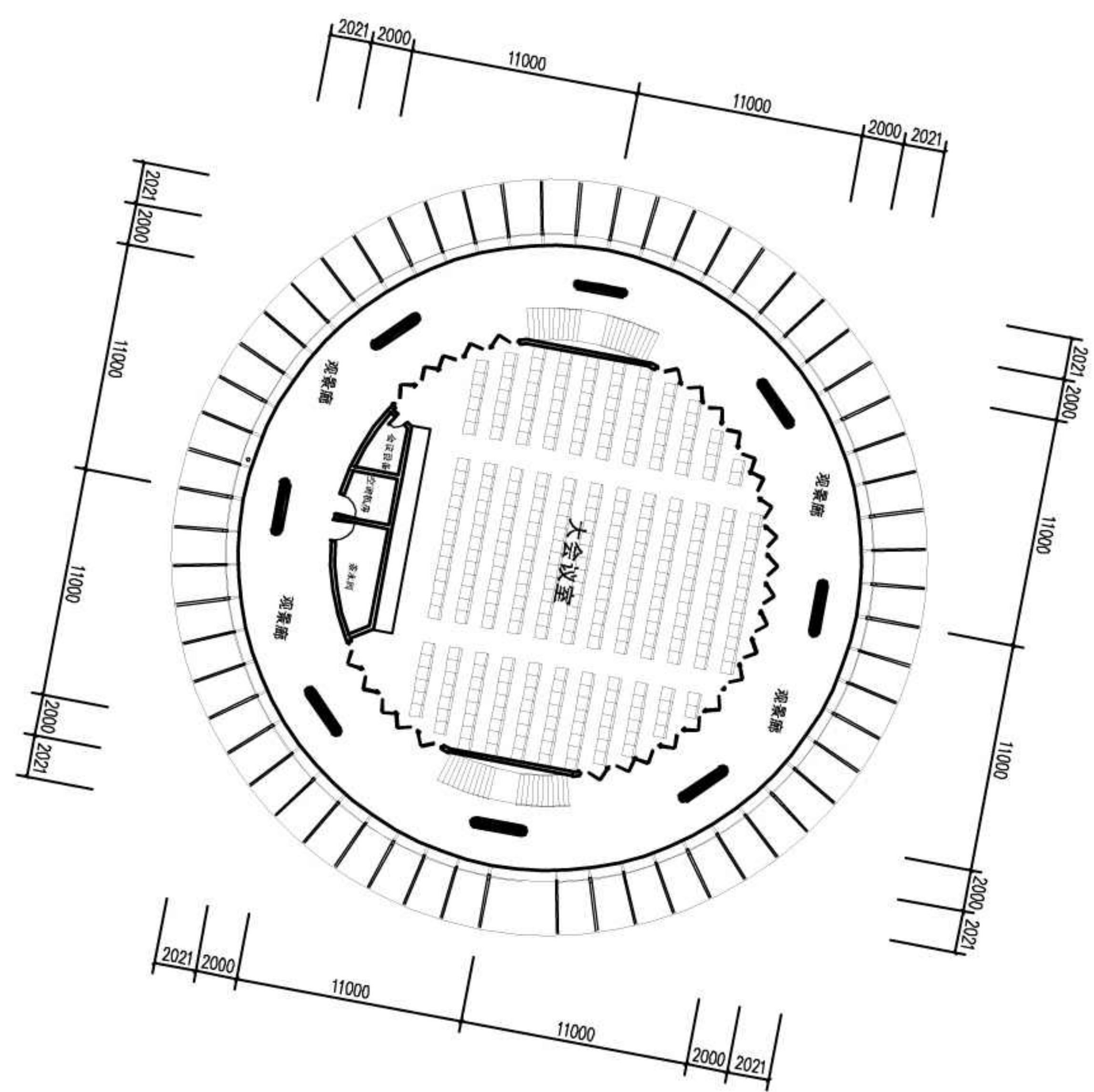

level 2f二层平面图 1:300



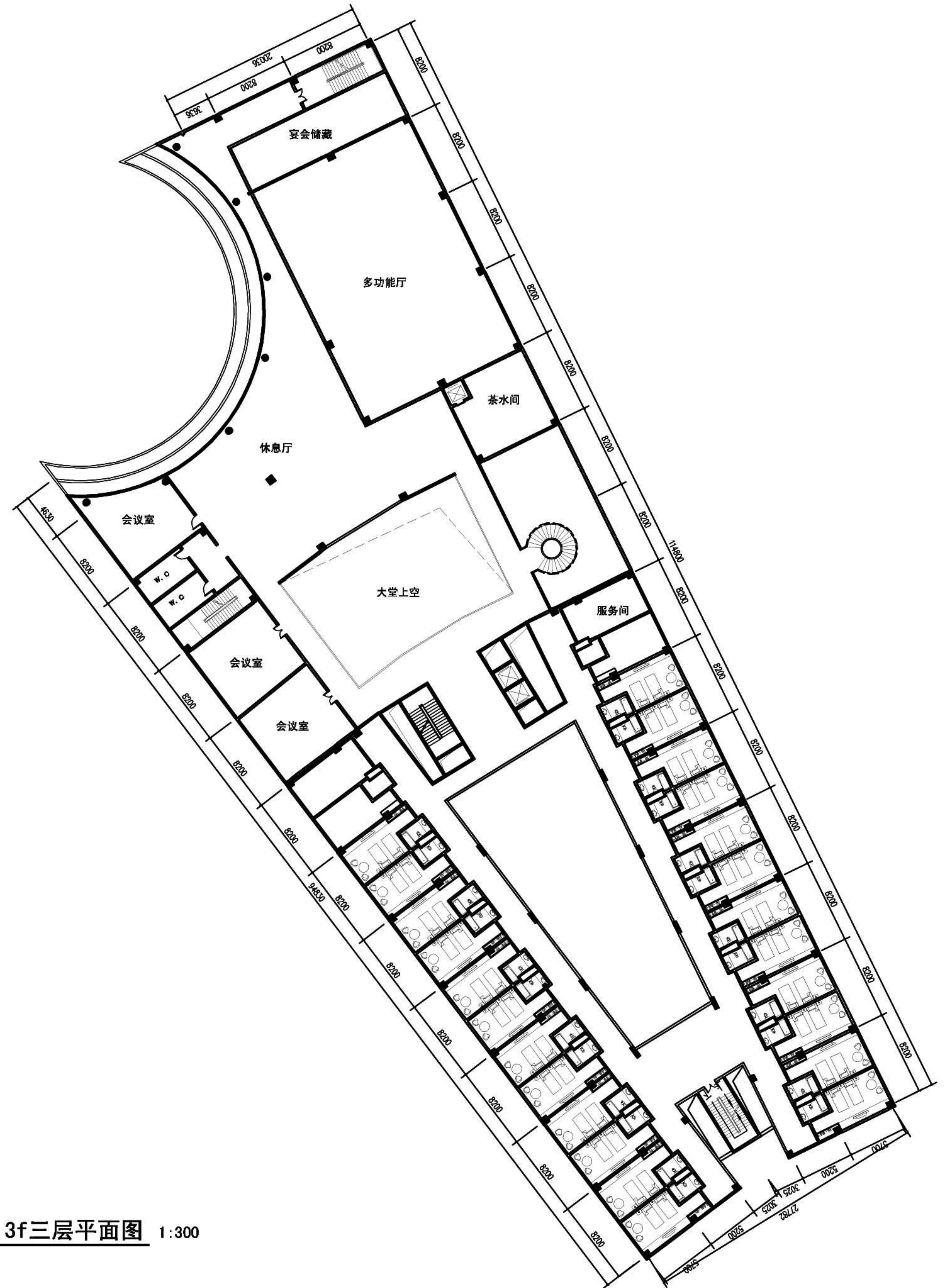
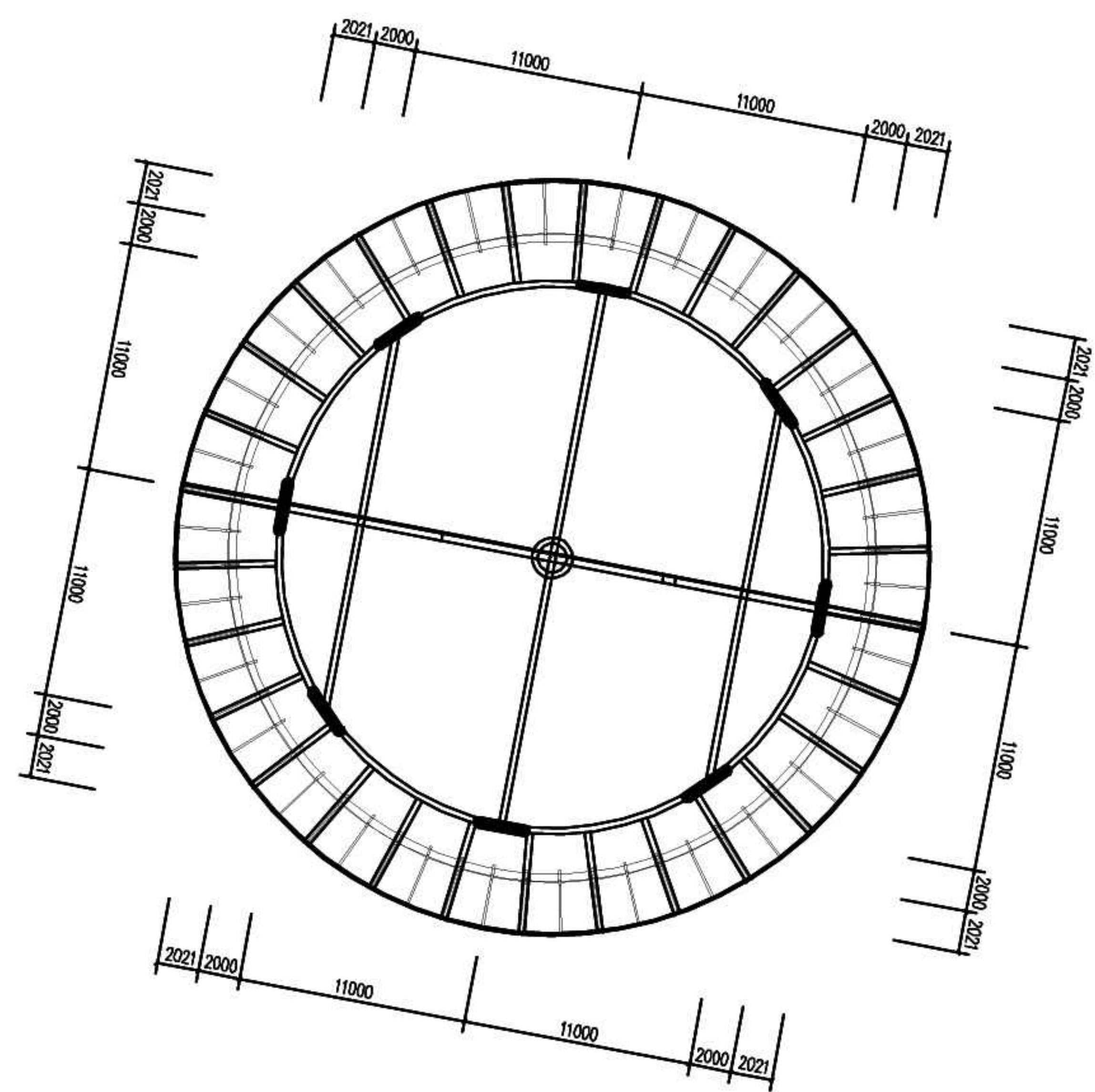

level 3f三层平面图 1:300



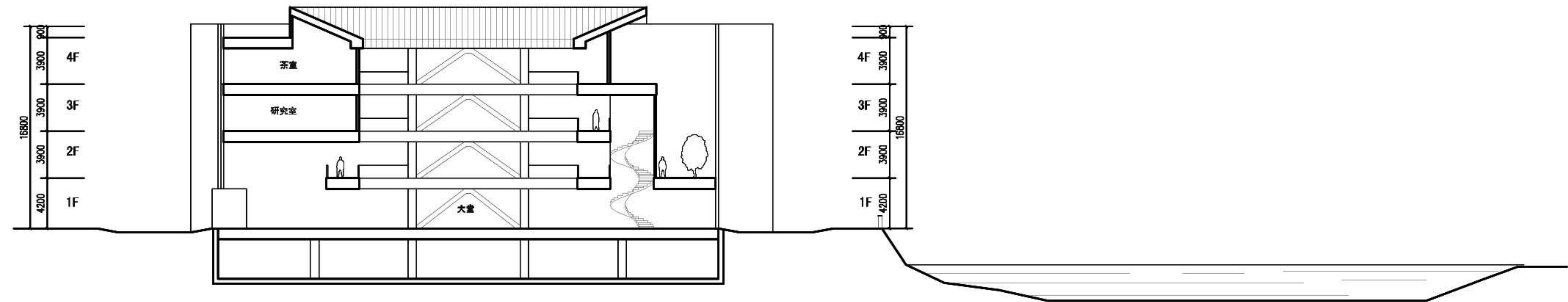
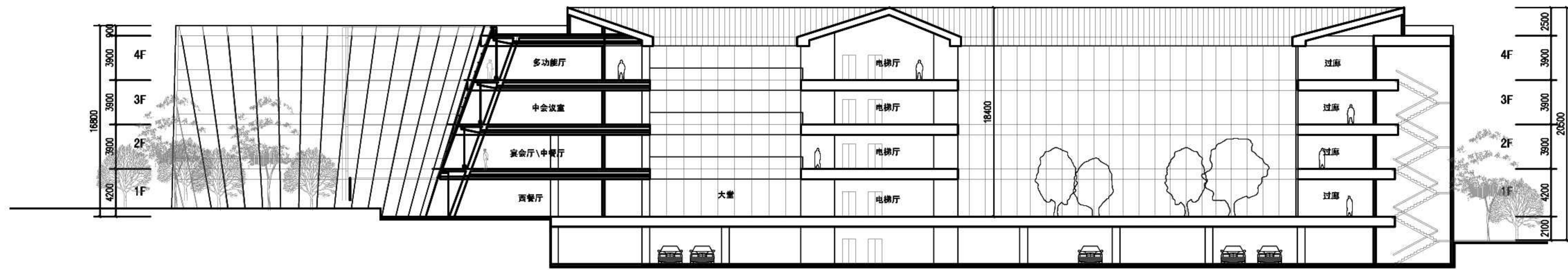



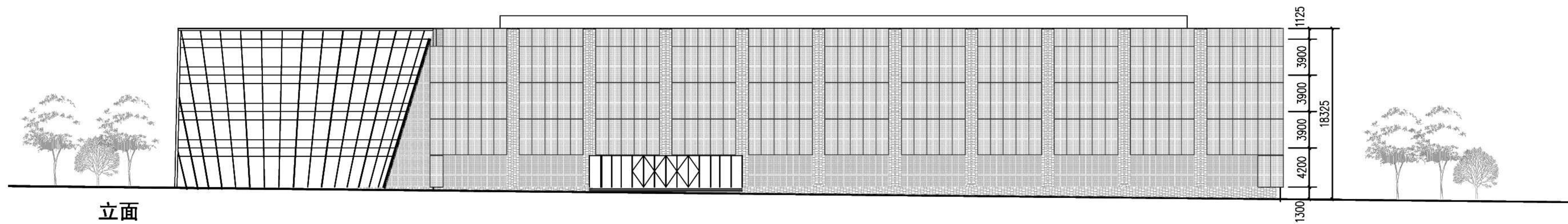

立面

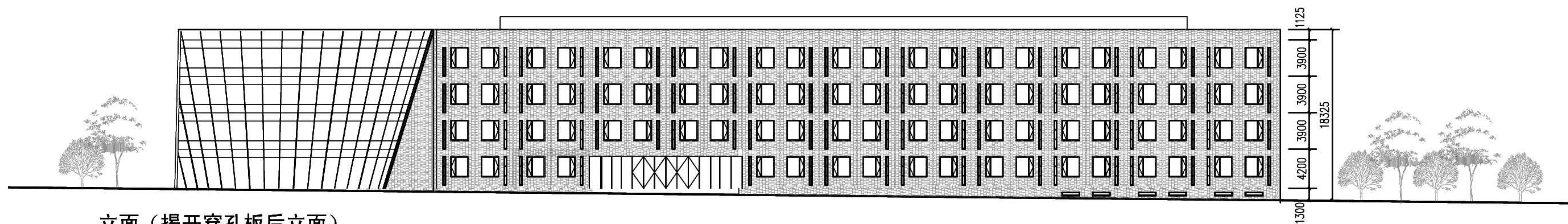

立面 (揭开穿孔板后立面)

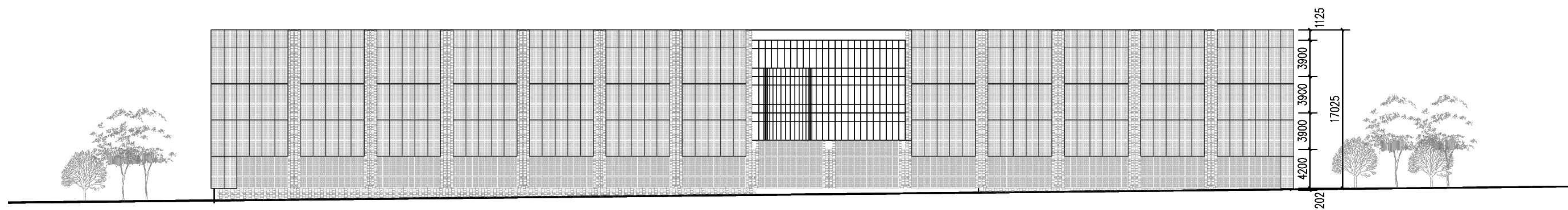

沿河立面